

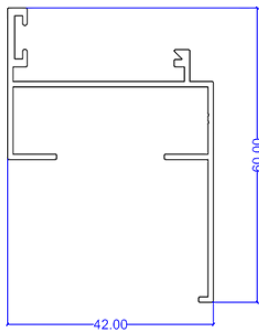

Doors Profiles

Aluminum door profiles are engineered for strength, durability, and smooth functionality. Used in residential, commercial, and industrial doors, they support various systems such as hinged, sliding, or pivot designs. Available in different finishes, thicknesses, and weights to match your project requirements.



TEK 504

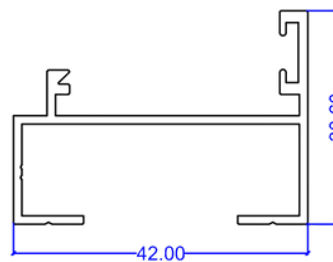

TEK 506

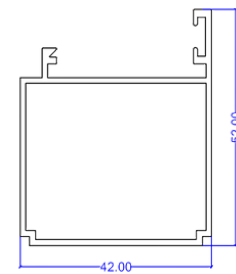

TEK 507

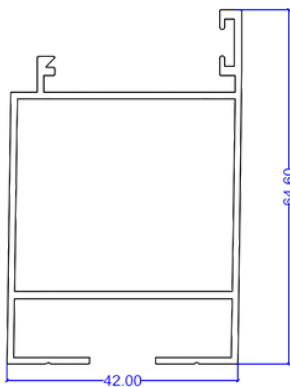

TEK 508

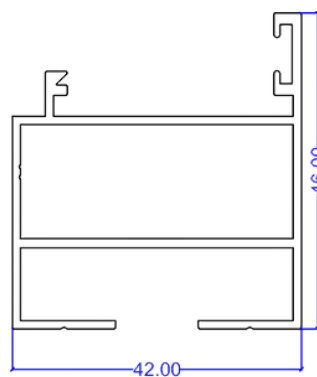

TEK 509

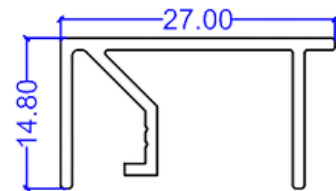

TEK 516



Door Hinges Profiles

Aluminum door hinge profiles are designed to ensure smooth, reliable movement and secure alignment of doors. They are used in both interior and exterior aluminum door systems, providing strength and long-lasting performance. Available in multiple finishes to match your door design and enhance durability.

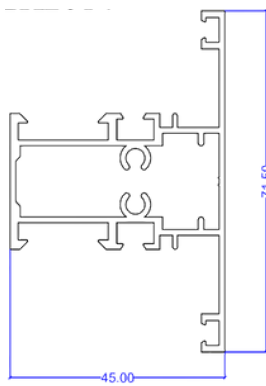

TEK 2014

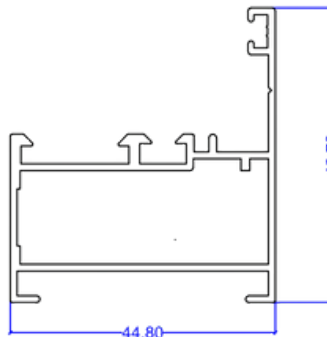

TEK 2015

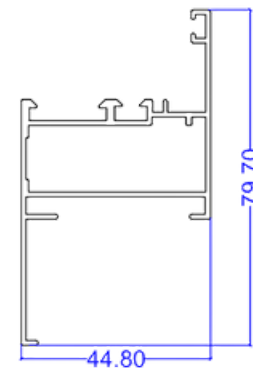

TEK 2016

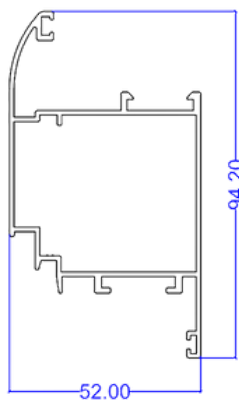

TEK 2017

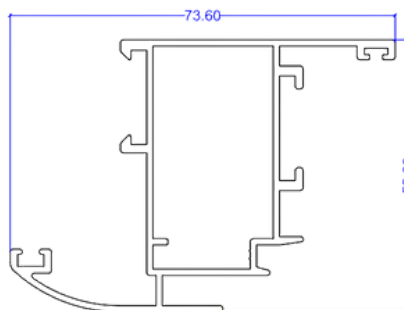

TEK 2018

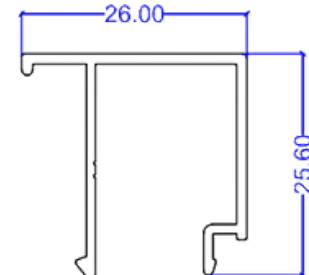

TEK 2019



Category: Door Hinges

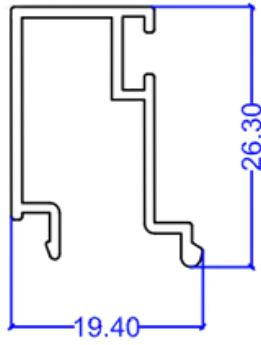

TEK 2020

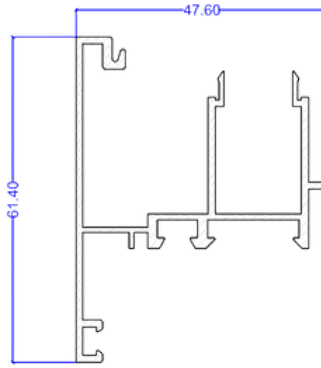

TEK 2022